

# Quick Start to CN3303 Demo Board

## 1. Introduction

Customers can use the CN3303 demo board for evaluation and debugging. A complete charging circuit can be built according to the components listed below.

In order to optimize the performance of CN3303, it should be studied with the “Design Example” mentioned on Page 11 of the CN3303 datasheet.

## 2. CN3303 Demo Board

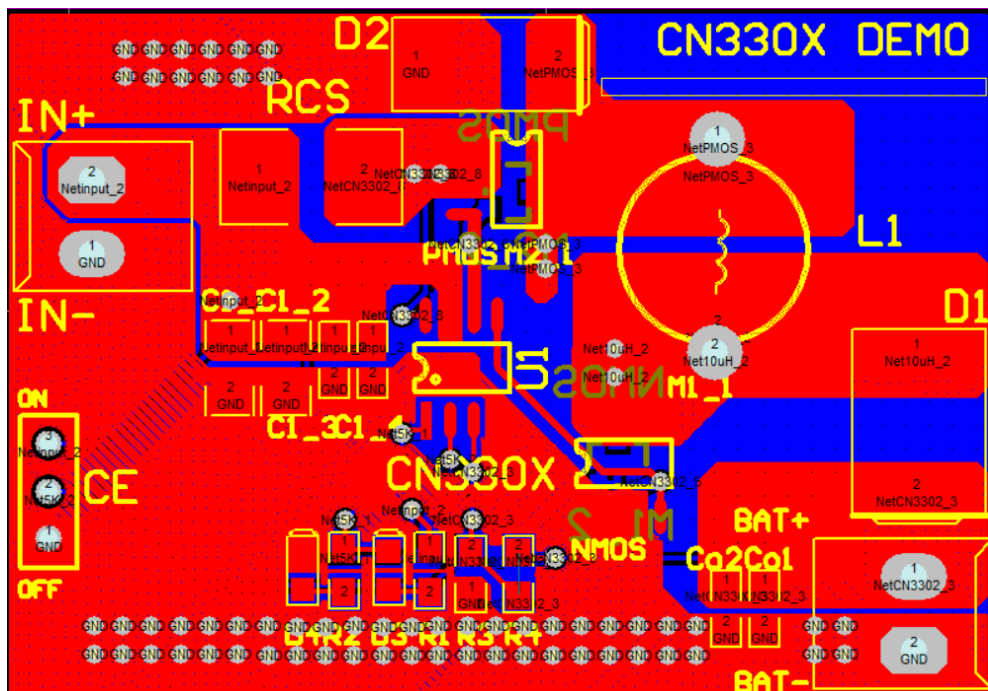

## 3. Component Description

#	Name	Description
1	IN+	Terminal for Power Input (Positive)
2	IN-	Terminal for Power Input (Ground)
3	BAT+	Connection to Battery Positive Terminal
4	BAT-	Connection to Battery Negative Terminal (Ground)
5	U1	CN3303
6	CE	Jumper (If it is connected to ON, CN3303 will active. If it is connected to OFF, CN3303 will be disable.)
7	R1	Resistor for Charge Termination LED Indicator
8	R2	Resistor for Charge Status LED Indicator
9	R3	Do not use

#	Name	Description
10	R4	Resistor for Programming Battery Voltage (0Ω is recommended.)
11	RCS	Current Sense Resistor (Please refer to CN3303 datasheet.)
12	L1	Inductor (Please refer to CN3303 datasheet.)
13	D1	Schottky Diode (Please refer to CN3303 datasheet.)
14	D2	Schottky Diode (Please refer to CN3303 datasheet.)
15	D3	Charge Termination LED Indicator
16	D4	Charge Status LED Indicator
17	M1_1/M1_2	NMOS; One or both are connected. (Please refer to CN3303 datasheet.)
18	M2_1/M2_2	PMOS; One or both are connected. (Please refer to CN3303 datasheet.)
19	C1_1/C1_2/ C1_3/C1_4	Capacitors for Power Input (Please refer to CN3303 datasheet.)
20	Co1/Co2	Capacitors for Power Output (Please refer to CN3303 datasheet.)